

Reliable®

Model G5-56, Model G5-42, Model G5-28 Quick Response Concealed Automatic Sprinkler

UL Quick Response FM Standard Response Concealed Sprinkler With a $\frac{3}{4}$ " (19mm) Adjustment

Features

1. Cover plate attachment (Plain or Perforated) with $\frac{3}{4}$ " (19mm) assembly adjustment.
2. Smooth aesthetic ceiling profile.
3. Factory installed protective cap.
4. Available in Chrome and White as Standard Finishes. Special Application Finishes are also available.
5. Ordinary and Intermediate temperature rating.

For additional Sprinklers refer to Bulletin 154 for Technical Specification and Approvals

Approvals & Listings

1. Underwriters Laboratories Inc. and cULus - Quick Response
 - G5-56 - Light Hazard and Ordinary Hazard Occupancies
 - G5-42 - Light Hazard Occupancies
 - G5-28 - Light Hazard Occupancies
2. Factory Mutual Research Corp. (FM) - Standard Response (See Page 3)
 - See the most recent FM Global Property Loss Prevention Data Sheets for installation and use guidelines.
3. Loss Prevention Council (LPCB, UK) - Standard Response
 - G5-56 - Light Hazard and Ordinary Hazard Occupancies
4. VdS Schadenverhütung GmbH - Standard Response
5. EC-Certificate of Conformity 0832-CPD-2062

U.S. Patent number 6,554,077.

Application

The Reliable Model G5-56, G5-42 and G5-28 are the most versatile quick response concealed sprinklers available. It provides the best form of fire protection while offering an attractive appearance and $\frac{3}{4}$ " (19mm) of cover adjustment for ease of installation. The small diameter cover plate assembly is easily attached and blends into the ceiling, concealing the most dependable fire protection available, an automatic sprinkler system.



Plain Cover Plate



Perforated Cover Plate

The Model G5-56, G5-42 and G5-28 are designed for use where aesthetic appearance is important. Offices, hospitals, motels and restaurants are but a few of the applications where it can be used.

The Model G5-56, G5-42 and G5-28 are UL Listed Quick Response Concealed sprinklers intended for use in accordance with NFPA 13. FM Approves the G5-56 and the G5-28 sprinkler as a standard response concealed sprinkler intended for use in accordance with FM Loss Prevention Data Sheet 2.0.

Product Description

The Reliable Model G5-56, G5-42 and G5-28 uses a proven quick response fusible element in a standard style sprinkler frame with a drop-down deflector. This assembly is recessed into the ceiling and concealed by a flat cover plate assembly. The threaded engagement provides $\frac{3}{4}$ " (19mm) of cover adjustment. The flat cover plate is attached to the skirt using either 135°F (57°C) or 165°F (74°C) ordinary temperature classification solder.

When the ceiling temperature rises, the solder holding the flat cover plate melts, the flat cover plate released thus exposing the sprinkler inside to the rising ambient temperature.

The subsequent fusing of the element opens the waterway and causes the deflector to distribute the water. Any secure engagement between the cover plate and cup will assure that the drop-down deflector is properly located below the ceiling.

The Reliable Automatic Sprinkler Co., Inc., 103 Fairview Park Drive, Elmsford, New York 10523

Installation

Do not install the G5-56, G5-42 and G5-28 in ceilings which have positive pressure in the space above.

- Cut a 2⁵/₈" inch (67mm) diameter hole is cut in the ceiling, the sprinkler is easily installed with the Model FC Wrench. The wrench has a socket drive which is inserted into the body of the sprinkler. When installing a sprinkler the wrench is first positioned into the sprinkler/cup assembly until the wrench socket engages the body of the sprinkler. The sprinkler is then tightened into the pipe fitting. When inserting or removing the wrench from the sprinkler/cup assembly, care should be taken to prevent damage to the sprinkler. **DO NOT WRENCH ON ANY OTHER PART OF THE SPRINKLER/CUP ASSEMBLY.** Install the cover plate by hand turning the cover in the clockwise direction until it is tight against the ceiling.

A protective cap is provided to protect the drop-down sprinkler deflector from damage which could occur during construction before the cover plate is installed. The cap is factory installed inside the sprinkler cup. Remove cap to install sprinkler, then re-install cap until the cover plate is installed.

Maintenance

The Model G5-56, G5-42 and G5-28 should be inspected quarterly and the sprinkler system maintained in accordance with NFPA 25. Do not clean sprinklers with soap and water, ammonia or any other cleaning fluids. Remove any sprinkler that has been painted (other than factory applied) or damaged in any way. Concealed sprinklers cover plates can not be painted in the field, after installation or have any other coating applied other than the factory finish. A stock of spare sprinklers should be maintained to allow quick replacement of damaged or operated sprinklers. Prior to installation, sprinklers should be maintained in the original cartons and packaging to minimize the potential for damage to sprinklers that would cause improper operation or non-operation.

Ordering Information

1. Sprinkler Model
2. Nominal Orifice
3. Flat Cover Plate
Plain or Perforated
4. Flat Cover Plate
Assembly Finish
5. Inlet Type

Cover Plate Finishes⁽¹⁾

Standard Finishes
Chrome
White Paint
Special Application Finishes ⁽²⁾
Bright Brass
Finished Bronze
Black Plating
Black Paint
Off White
Satin Chrome

⁽¹⁾ Other finishes and colors are available on special order. Consult factory for details. Coverplate custom paint is semi-gloss, unless specified otherwise.

⁽²⁾ For the perforated style coverplate, consult factory for availability on these and other custom finishes.



Model FC Sprinkler Wrench

UL Listing Category

Sprinklers, Automatic and Open
Quick Response Sprinkler

UL Guide Number

VNIV

Maximum Working Pressure

175 psi (12 bar)

100% Factory tested Hydrostatically to 500 psi (34.5 bar)

Temperature Rating

Classification	Sprinkler	Cover Plate	Max. Ambient Temp.
Ordinary	165°F/74°C	135°F/57°C	100°F/38°C
Intermediate	212°F/100°C	165°F/74°C	150°F/66°C

Technical Data

Sprinkler Model	Sprinkler Inlet	Total Adjustment	Nominal Orifice	Nominal K Factor		Thread	Approvals	Sprinkler Identification (SIN)
				US	Metric			
G5-56	Non Adjustable	3/4" (19mm)	1/2" (15mm)	5.6	80	1/2" NPT (R1/2)	1,2,3,4,5	RA3415
G5-42	Non Adjustable	3/4" (19mm)	7/16" (10mm)	4.2	60	1/2" NPT (R1/2)	1	RA3413
G5-28	Non Adjustable	3/4" (19mm)	3/8" (10mm)	2.8	40	1/2" NPT (R1/2)	1,2	RA3411

For VdS Approval, temperature rating sprinkler 165°F/74°C and cover plate 135°F/57°C only!

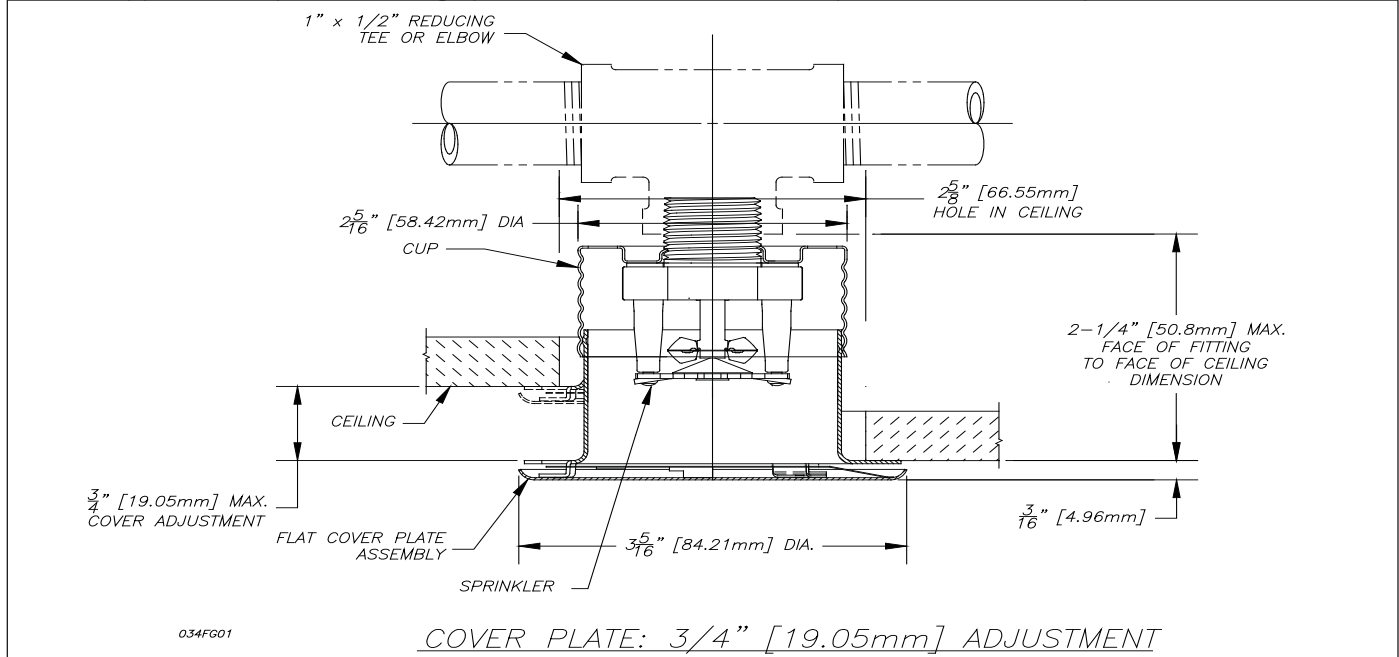

Notice

FOR USE AS A REPLACEMENT OF MODEL G4A SPRINKLERS

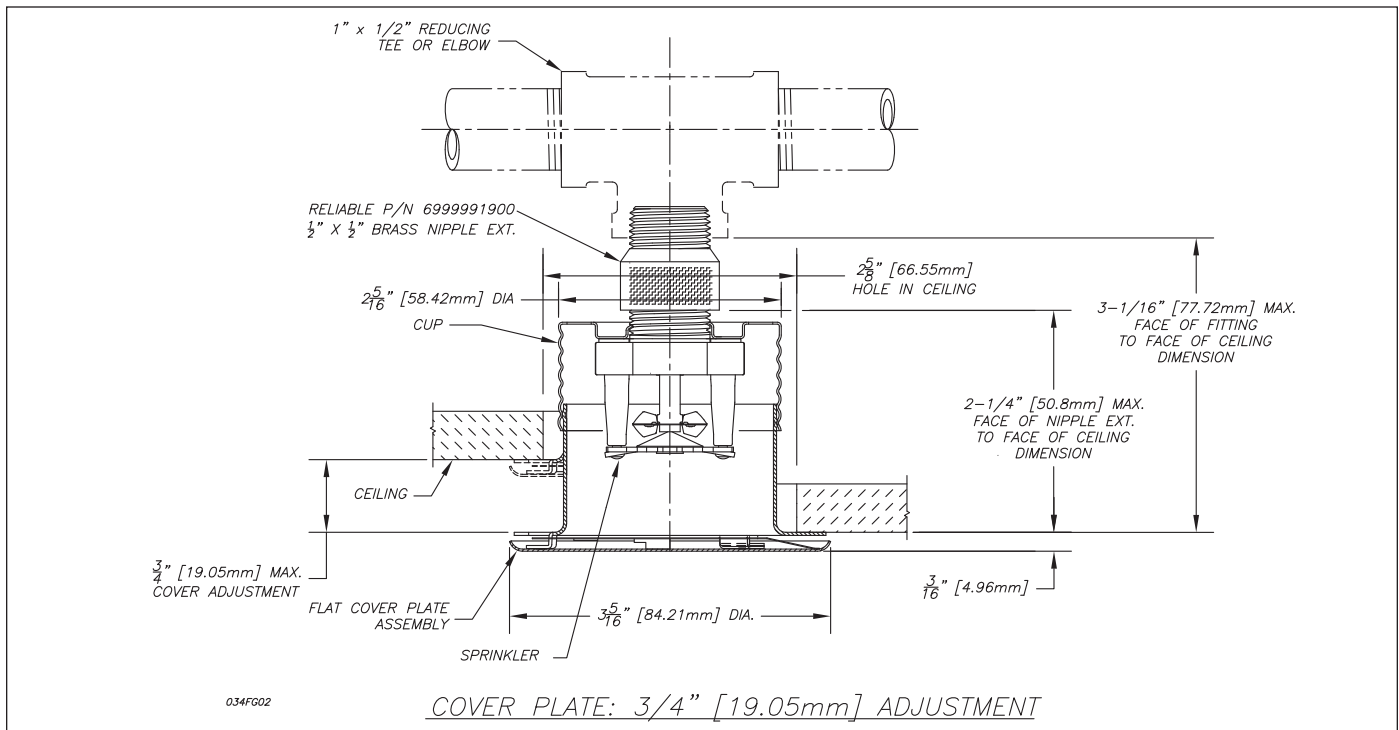

NOTE:

1. Testing has shown that use of a "nipple extension" will not affect the listing of the sprinkler.
2. For RETROFIT installations, per **NFPA 13 (2010) section 8.15.19.4**, "which allows the use of nipples as the same pipe thread size as the existing outlet when revamping existing systems".
3. Do not exceed 8-18 ft-lbs of torque during installation.

Reliable...For Complete Protection

Reliable offers a wide selection of sprinkler components. Following are some of the many precision-made Reliable products that guard life and property from fire around the clock.

- Automatic sprinklers
- Flush automatic sprinklers
- Recessed automatic sprinklers
- Concealed automatic sprinklers
- Adjustable automatic sprinklers
- Dry automatic sprinklers
- Intermediate level sprinklers
- Open sprinklers
- Spray nozzles
- Alarm valves
- Retarding chambers
- Dry pipe valves
- Accelerators for dry pipe valves
- Mechanical sprinkler alarms
- Electrical sprinkler alarm switches
- Water flow detectors
- Deluge valves
- Detector check valves
- Check valves
- Electrical system
- Sprinkler emergency cabinets
- Sprinkler wrenches
- Sprinkler escutcheons and guards
- Inspectors test connections
- Sight drains
- Ball drips and drum drips
- Control valve seals
- Air maintenance devices
- Air compressors
- Pressure gauges
- Identification signs
- Fire department connection

The equipment presented in this bulletin is to be installed in accordance with the latest published Standards of the National Fire Protection Association, Factory Mutual Research Corporation, or other similar organizations and also with the provisions of governmental codes or ordinances whenever applicable.

Products manufactured and distributed by Reliable have been protecting life and property for over 90 years, and are installed and serviced by the most highly qualified and reputable sprinkler contractors located throughout the United States, Canada and foreign countries.

Manufactured by

Reliable[®]

The Reliable Automatic Sprinkler Co., Inc.

(800) 431-1588

(800) 848-6051

(914) 829-2042

www.reliablesprinkler.com

Sales Offices

Sales Fax

Corporate Offices

Internet Address



Recycled
Paper

Revision lines indicate updated or new data.

EG. Printed in U.S.A. 09/12

P/N 9999970421